

# OXO Connect 2.1

## 8018 DeskPhone

### User Manual

8AL90331USACed01-1712



## Introduction

Thank you for choosing your DeskPhone. We hope it will give you entire satisfaction. This model offers enhanced ergonomical features for more effective communication. It is compatible with teleworking. Consequently, it is perfect for use at your office in your enterprise or at home (teleworking).

This manual describes the services offered by the 8018 DeskPhone connected to an OXO Connect system.

<b>1</b>	<b><u>GETTING TO KNOW YOUR TELEPHONE.....</u></b>	<b><u>6</u></b>
1.1	8018 DESKPHONE.....	6
1.2	DESCRIPTION OF THE CONNECTORS .....	6
1.3	WELCOME SCREENS.....	7
1.4	NAVIGATION .....	7
1.5	CHANGING OR UPDATING THE PAPER LABEL.....	8
1.6	STATUS ICONS.....	8
1.7	CALL ICONS .....	8
1.8	FEATURES KEYS .....	9
1.9	PREPROGRAMMED KEYS.....	9
1.10	ALPHABETIC KEYPAD.....	9
1.11	CALL MANAGEMENT SCREEN.....	10
<b>2</b>	<b><u>USING YOUR TELEPHONE .....</u></b>	<b><u>11</u></b>
2.1	MESSAGING PORTAL .....	11
2.2	CONSULTING THE CALL LOG .....	12
2.3	MAKING A CALL .....	13
2.4	RECEIVING A CALL .....	14
2.5	USING THE TELEPHONE IN 'HANDS FREE' MODE .....	14
2.6	ACTIVATING THE LOUDSPEAKER DURING A CONVERSATION (HANDSET LIFTED)-LOUDSPEAKER. ....	14
2.7	CALLING A CONTACT USING THE SEARCH BY NAME FEATURE.....	15
2.8	MAKE CALLS VIA YOUR PROGRAMMED CALL KEYS .....	16
2.9	FILTERING CALLS USING THE VOICE MAILBOX.....	16
2.10	REDIALING .....	17
2.11	REQUESTING AUTOMATIC CALLBACK IF INTERNAL NUMBER IS BUSY.....	17
2.12	CANCELLING AN AUTOMATIC CALLBACK .....	17
2.13	RECEIVING INTERCOM CALLS .....	17
2.14	SENDING DTMF SIGNALS .....	18
2.15	MUTE, SO THAT YOUR CALLER CANNOT HEAR YOU.....	18
2.16	SENDING AN INSTANT MESSAGE TO A CONTACT .....	18
2.17	ANSWERING WITH AN INSTANT MESSAGE .....	19
2.18	CONSULTING INSTANT MESSAGES.....	21
<b>3</b>	<b><u>DURING A CONVERSATION .....</u></b>	<b><u>22</u></b>
3.1	MAKING A SECOND CALL DURING A CONVERSATION .....	22
3.2	ANSWERING A SECOND CALL DURING A CONVERSATION .....	23
3.3	SWITCHING BETWEEN CALLS (BROKER CALL) .....	23
3.4	TRANSFERRING A CALL .....	23
3.5	TRANSFER A CALL TO A VOICE MAIL .....	24
3.6	THREE-WAY CONFERENCE WITH INTERNAL AND/OR EXTERNAL CALLERS (CONFERENCE) .....	24
3.7	PLACING A CALL ON HOLD (HOLD) .....	24
3.8	PLACING AN OUTSIDE CALL ON HOLD (PARKING) .....	25
3.9	INTRUSION INTO AN INTERNAL CONVERSATION .....	25
3.10	STORE A NUMBER .....	25
3.11	ADJUST AUDIO VOLUME .....	25
<b>4</b>	<b><u>'MEET ME' CONFERENCE .....</u></b>	<b><u>26</u></b>
4.1	INITIATE A 'MEET ME' CONFERENCE.....	26
4.2	JOIN A 'MEET ME' CONFERENCE .....	26

<b>5</b>	<b>SHARING</b>	<b>27</b>
5.1	RECEIVING SUPERVISED CALL RINGING	27
5.2	ANSWERING THE GENERAL BELL	27
5.3	MANAGER/ASSISTANT FILTERING	27
5.4	CALL PICK-UP	27
5.5	HUNTING GROUPS	28
5.6	CALLING AN INTERNAL CALLER ON HIS/HER PAGER	28
5.7	ANSWERING A CALL ON YOUR PAGER	28
5.8	CALLING A CALLER ON HIS/HER LOUDSPEAKER	29
5.9	SEND A VOICE MESSAGE COPY	29
5.10	SENDING A RECORDED MESSAGE TO A NUMBER OR A DISTRIBUTION LIST	29
5.11	BROADCASTING A MESSAGE ON THE LOUDSPEAKERS OF A STATION GROUP	30
<b>6</b>	<b>KEEP IN TOUCH</b>	<b>31</b>
6.1	SELECTING CALLS TO BE FORWARDED	31
6.2	FORWARDING CALLS TO ANOTHER NUMBER (IMMEDIATE FORWARD)	31
6.3	FORWARDING YOUR CALLS TO YOUR VOICE MESSAGE SERVICE	31
6.4	WHEN YOU RETURN, CONSULT RECORDED MESSAGES	31
6.5	ACTIVATE/DISABLE THE PERSONAL ASSISTANT	32
6.6	PERSONAL ASSISTANT: REACHING YOU WITH ONE NUMBER ONLY	32
6.7	FORWARDING CALLS TO YOUR PAGER	32
6.8	FORWARDING YOUR CALLS FROM THE RECEIVING TERMINAL ('FOLLOW ME')	33
6.9	DIVERTING ALL GROUP CALLS	33
6.10	CANCELLING ALL FORWARDS	33
6.11	CANCELLING A SPECIFIC FORWARD	33
6.12	FORWARDING CALLS WHEN YOUR LINE IS BUSY (FORWARD IF BUSY)	33
6.13	DO NOT DISTURB	34
6.14	LEAVING A RECORDED MESSAGE FOR INTERNAL CALLERS	34
6.15	CONSULTING WRITTEN MESSAGES	35
6.16	MESSAGE NOTIFICATION	35
<b>7</b>	<b>PROGRAMMING YOUR TELEPHONE</b>	<b>36</b>
7.1	INITIALIZING YOUR VOICE MAILBOX	36
7.2	CUSTOMIZING YOUR VOICE GREETING	36
7.3	MODIFYING YOUR PERSONAL CODE	36
7.4	ADJUSTING THE AUDIO FUNCTIONS	37
7.5	ADJUSTING THE CONTRAST OF THE DISPLAY	37
7.6	SELECTING THE WELCOME PAGE	38
7.7	SELECTING LANGUAGE	38
7.8	PROGRAM THE KEYS FOR THE PERSO PAGE	38
7.9	PROGRAMMING DIRECT CALL KEYS (PROGRAMMED KEYS WITH LEDs)	38
7.10	MODIFY THE PROGRAMMED KEY	39
7.11	DELETE A PROGRAMMED KEY	39
7.12	PROGRAMMING AN APPOINTMENT REMINDER	40
7.13	IDENTIFY THE TERMINAL YOU ARE ON	40
7.14	LOCK / UNLOCK YOUR TELEPHONE	40
7.15	ACTIVATING/DEACTIVATING 'FORCED HEADSET' MODE	40
7.16	INSTALL A USB ACCESSORY (HEADSET, HANDSFREE, LOUDSPEAKER)	41
7.17	CONFIGURE YOUR PHONE FOR TELEWORKING	41

---

7.18	CONTACTING YOUR ADMINISTRATOR .....	45
<b>8</b>	<b><u>ACD: AGENT SET/ SUPERVISOR STATION .....</u></b>	<b>46</b>
8.1	AGENT SET .....	46
8.2	OPEN AN AGENT SESSION (LOGIN) – AGENT SET .....	46
8.3	ACD APPLICATION WELCOME SCREEN – AGENT SET .....	46
8.4	THE FOUR OPERATING STATUSES OF THE AGENT SET .....	47
8.5	CHANGING THE OPERATING STATUS OF THE SET – AGENT SET .....	47
8.6	MODIFYING YOUR PERSONAL CODE – AGENT SET .....	47
8.7	INTEGRATING ANOTHER GROUP/LEAVING A GROUP – AGENT SET .....	47
8.8	CLOSE THE AGENT SESSION (LOGOUT) – AGENT SET .....	47
8.9	SUPERVISOR STATION .....	48
8.10	SUPERVISING GROUP MAILBOXES – SUPERVISOR STATION .....	48
<b>9</b>	<b><u>GUARANTEE AND CLAUSES .....</u></b>	<b>49</b>
9.1	SAFETY INSTRUCTIONS .....	49
9.2	REGULATORY STATEMENTS .....	50

The labels and icons presented in this document are not contractually binding and may be modified without prior warning.

Copyright© ALE International 2017





# 1 Getting to know your telephone

## 1.1 8018 DeskPhone

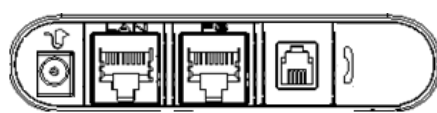

Your phone has 4 programmable keys with led and paper label. These keys are use to program a direct call. You can use the paper to describe the key.

## 1.2 Description of the connectors





	10/100/1000 Gigabit Ethernet connector (LAN).	
	10/100/1000 Gigabit Ethernet connector (PC).	
	DC power jack for an external power adaptor.	
	RJ9 connector for a corded handset.	
	USB connector for headset.	

## 1.3 Welcome screens

You can access all of your phone's features from these screens. The default display has three pages that you can access by selecting the corresponding tab at the top of the screen with the navigation keys. The selected page is highlighted.

- Menu.
- Perso.
- Info.



- **Menu page:**  
Contains all features and applications, which are accessed by pressing the key corresponding to the desired feature or application. From this page it is possible to adjust the ringer volume, program the time of an appointment, lock the terminal, define the default page displayed and access telephone functions such as calling back one of the last numbers or intercepting calls.
- **Perso page:**  
Contains call line keys (allowing supervision of calls) and programmable call keys.
- **Info page:**  
Contains information on the telephone and the status of its functions: name, telephone number, number of messages, activation of transfer function, appointment reminder, etc.
-  **Forward icon**  
Press the key next to this icon allows you to program or change the transfer function.
  -  Stationary white icon: No forwarding activated.
  -  Rotating black icon: Forwarding activated.
-  Press the key in front of the label to select the corresponding feature.

## 1.4 Navigation

### OK key:



- Use to validate your choices and options while programming or configuring.
- Use to validate an edited text.
- Use to switch off/on the screen when the phone is in idle mode.

### Left-right navigator:



- Use to move from one page to another and display information about current calls (call in progress, calls on hold, incoming call).
- Use to navigate into a text box.

### Up-down navigator:



Use to scroll through the content of a page.

### Back/Exit/Backspace key:



- Use this key to go back to the previous step.
- Use this key to go back to the homepage (long press).
- Use this key to delete one number or character at a time.



## 1.5 Changing or updating the paper label

### Removing the paper label

- Lift the protective cover at the notch and slide it up to take it out of its housing.
- Remove the upper label in the same way.
- Update or replace the paper label.



### Inserting the phone label

- Insert the paper label from the top end, making sure it is placed correctly behind the notches.
- Put the protective cover back in the same way.





## 1.6 Status icons

Icons giving information about some specific configurations of the phone are displayed in the top bar of the screen.

	Headset connected.
	Telephone locked.
	Appointment programmed.







## 1.7 Call icons

Icons giving information about call status are displayed in the tabs of the communication window.

	Incoming call icon.
	Call in progress icon.
	Call holding icon.



## 1.8 Features keys

	Mute and intercom key. During a call, press this key to stop your contact from hearing you. When idle, press this key to switch the phone to intercom mode. When you receive a call, the phone hooks off automatically and you go straight into handsfree mode. This key lights up blue when activated.
	Turn down the volume / Lower the contrast.
	Turn up the volume / Increase the contrast.
	Pressing this key answers an incoming call in handsfree mode (the key is blue). When a call is in progress, pressing this key switches from handsfree mode to headset or handset mode.
	Messaging key to access various mail services. This key flashes when you have a new event (voicemail, text message or callback request) and stays lit until all events have been acknowledged or deleted. Access the call log.
	The redial key is associated with the off hook key when the phone is in idle state. <ul style="list-style-type: none"> <li>• Last number redial (short press).</li> <li>• Call back one of the last 8 numbers dialed (long press).</li> </ul>

The hands-free mode can be deactivated by the administrator.

## 1.9 Preprogrammed keys



The 8018 DeskPhone uses 3 preprogrammed keys to access some features. In this case, the icon of the feature is printed on the paper. Use the feature by pressing the corresponding key. When activated, the LED corresponding to the key remains lit up. Press the corresponding key to deactivate it.



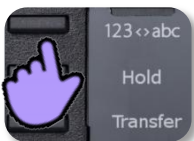

- **123<>abc** Alpha-numerical keypad  
Use this key to switch between alphabetic keyboard and numeric keyboard.
- **Hold** Use this key to put the call on hold.
- **Transfer** Use this key to transfer a call.

## 1.10 Alphabetic keypad



Your phone is equipped with alphanumeric keyboard. You can switch between numeric keyboard to dial number, and alphabetic keyboard to enter text by pressing the corresponding programmed key (usually the first programmed key).

- **123<>abc** Switch the keyboard to the alphabetic mode by selecting the associated programmed key. When activated, the LED corresponding to the key remains lit up.
- Enter alphabetic characters.  
The number pad keys have letters that you can display by successive presses. The number is the last character in the series. Some special characters can be displayed by successively pressing the key:

	% \$ / ~ & ( ) [ ] = *
	@ #
	space - _ 1
	+ . , ; : / \ ? ! 0



- Use navigation keys to move the cursor into the text.



- delete the last entered character. The alphabetic mode remains activated.



- Select the lit programmed key to return to the numeric mode.

### 1.11 Call management screen

Incoming call icon, Call in progress, Call on hold, ...

Incoming call and conversation presentation screen

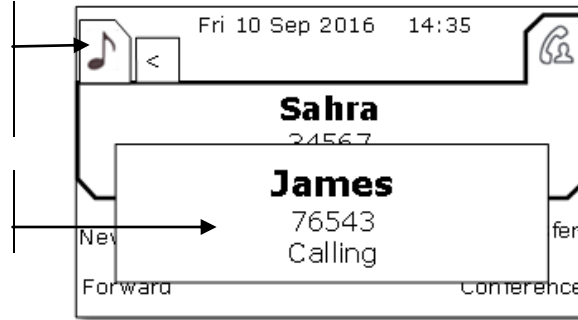

Soft keys: actions available depending on the call status



Each tab corresponds to a call, the status of which is symbolized by its icon (in progress, call on hold, arrival of new call). When a call is in progress, use the left-right navigator to look at calls on hold or incoming calls.



All features are accessible while the call is displayed on the screen. Use the Up and Down arrows to move up or down a page. These functions (transfer, conference, etc.) are directly related to the status of the call consulted. For example, the transfer function will not be available between a call in progress or a call on hold and an incoming call.



Used to switch from a telephone screen to an application screen. For example, it can be used while a call is in progress to search a number, program an appointment reminder, etc.



Press the key in front of the label to select the corresponding feature.

Calls can also be managed from the Perso page.

While the call is in progress, press the Back/Exit key and display the Perso page. Calls in progress or waiting calls are displayed on the different line keys. It is then possible to converse with the caller of your choice by pressing the key associated to the caller.

## 2 Using your telephone

### 2.1 Messaging portal

The messaging portal allows you to access and manage features such as the call log, instant messaging and voice messages. When there is a new event (new log, new instant message or new voice message) the message key blinks blue.

#### Accessing the messaging portal



-  Press the message key to access the messaging portal.
- Enter your password if required.

#### Configure access to the messaging portal

The system default setting requires you to enter your personal password to access the messaging portal features

The password information is retained for a few seconds so that if you quit the messaging portal you can access it again after a few seconds without having to re-enter your password. The length of this time-out depends on your system configuration. For more information, contact your installer or administrator.

You can change the setting so that you don't have to enter a password each time you want to access the messaging portal features.



-  Access the messaging portal (Enter your password if required).
- *Config*
- *Authentication*
- Enter your personal password.
- Set authentication to on or off.  
On: password is always required.  
Off: password is never required.
-  Press or select OK to confirm.

#### Accessing the features of the messaging portal

To access the available features (call log, instant messages IM, voice messages, sending an instant message), press the associated softkey.



#### Acknowledging

When you consult a new event (call log, instant message or voice message), the event is automatically acknowledged. However, you can choose to acknowledge all events without consulting them.

-  Press the softkey associated with the type of event you want to acknowledge. If you press the key associated with the 'all' option, all new events are acknowledged. You can also acknowledge all events if you press the softkey associated with the check icon in the top right corner of the screen.
-  Press or select OK to confirm.

#### Deleting

When consulting an event (call log, instant message or voice message), you can delete the event once you have consulted it. However, you can choose to delete all events in one go.

-  Press the associated softkey.
-  Press the softkey associated with the type of event you want to delete.
-  Press or select OK to confirm.

## 2.2 Consulting the call log

At any time, you can consult all answered and unanswered incoming and outgoing calls. To do this, go to the call log feature on the messaging portal.

-  Access the messaging portal (Enter your password if required).
- Press the softkey associated with the call log feature.

You can choose between consulting missed calls only ('Missed' tab) and consulting all call logs including unanswered/answered, incoming and/or outgoing calls ('All' tab).

### Consulting missed calls



- Using the left/right navigator key, select the 'Missed' tab.  
Unacknowledged calls are in bold characters.
- Using the up and down navigation key, select the log to consult.
-  Display the log details.

Information such as the name, phone number, date and time are displayed on the screen.



You can choose to call the contact, send an instant message to the contact, save the contact in the personal phonebook, or clear the log.

#### Acknowledge all missed calls:

Once a new log is consulted, it is automatically acknowledged. However, you can acknowledge all new missed calls without consulting them.





-  Press the associated softkey.
-  Press the associated softkey.
-  Press or select OK to confirm.  
All missed calls are acknowledged.

#### Delete all missed calls:

-  Press the associated softkey.
-  Press the associated softkey.
-  Press or select OK to confirm.  
All missed calls are deleted.

## Consulting all calls



- Using the left/right navigator key, select the 'All' tab.  
All calls are displayed with an icon giving information on the type of call.

	Answered outgoing calls		Answered incoming calls
	Unanswered outgoing calls		Unanswered incoming calls



- Using the up and down navigation key, select the log to consult.
-  Display the log details.  
Information such as the name, phone number, date and time are displayed on the screen.

You can choose to call the contact, send an instant message to the contact, save the contact in the personal phonebook, or clear the log.

### Acknowledge all missed calls:







-  Press the associated softkey.
-  Press the associated softkey.
-  Press or select OK to confirm.  
All missed calls are acknowledged.

### Delete all call logs:

-  Press the associated softkey.
-  Press the associated softkey.
-  Press or select OK to confirm.  
All call logs are deleted.

## 2.3 Making a call

Use one of the following:

- Dial directly the number for your call.
- Lift the receiver  Enter the destination number.
-  Hands free  Dial the destination number.
- Programmed line key.
-  Search by name (access the search by name feature by selecting the alphabetic mode).
-  From call log after accessing the messaging portal.
-  Redial last number.

To make an external call, dial the outside line access code before dialing your contact number.

The duration of your external call may be limited in time by the administrator. In this case, a beep sounds and/or a message will be displayed on the screen 20 seconds before the end of the communication.

The hands-free mode can be deactivated by the administrator



## 2.7 Calling a contact using the search by name feature

**123<>abc** Use the alpha-numeric keyboard key to switch between the numeric and alphabetic keyboard.

You can call a contact using the search by name feature. This feature enables you to call a contact directly on their company phone or call them on another phone using their contact card.

The search by name feature provides two modes:



- *Internal*: Classic search of the corporate directory.
- *Unified*: Predictive search of the corporate directory.

Please be aware that predictive searching means that you won't have access to the contact card, and therefore can only call the contact on their company phone.

Switching between the two modes:

- **123<>abc** Switch the keyboard to the alphabetic mode by selecting the associated programmed key. When activated, the LED corresponding to the key remains lit up.
- Press a letter to launch the dial by name function.
-  *Options*
- The current mode is displayed.
- Select the new mode:
  - *Internal*: The internal directory mode is enabled.
  - *Unified*: The unified directory mode is enabled.
  - *OK*: Stay in the current mode.

### Calling a contact using the unified directory

- **123<>abc** Switch the keyboard to the alphabetic mode by selecting the associated programmed key. When activated, the LED corresponding to the key remains lit up.
- Enter the first letter of your contact's surname.  
When entering the name you can extend the search by adding the first letters of the first name after entering the '#' symbol or pressing: *1stname*.
-  Start the search.
- A list of matching names is displayed on the screen. Each contact is displayed with their name and company phone number.
- Use one of the following:
  -  Scroll and select your contact in the list of matching names.
  -  Modify the search.



### Call your contact using the company phone number

- Press the key associated with the company phone number.

### Call your contact using another phone number (via contact card):





- Press the softkey associated with the contact name:

The contact card opens and displays information about the contact: last name and first name, several phone numbers (Office, mobile, home), email address, instant message address and the company name.

-  Scroll through the screen with the up and down navigation keys and position the cursor on the contact phone number you wish to call.
-  Start the call.

You can switch to the other search mode by enabling it in the options menu (available once a search by name is started). Please be aware that predictive searching means that you won't have access to the contact card, and therefore can only call the contact on their company phone.

### Calling a contact using the internal directory (predictive search)

-  Switch the keyboard to the alphabetic mode by selecting the associated programmed key. When activated, the LED corresponding to the key remains lit up.
- Enter the first letter of your contact's surname. You enter your contact's name in predictive text mode. In this mode, enter each letter of the name by pressing only once on the key with this letter.
- The search runs as soon as you enter a character (predictive search). The matching names are displayed.
- Use one of the following:
  -   Display the previous and next names.
  -  Press the OK key to start the call with the displayed contact (company phone number).
  -  Modify the search.

You can switch to the other search mode by enabling it in the options menu (available once a search by name is started).

This feature depends on the system configuration. If necessary, contact your administrator...

## 2.8 Make calls via your programmed call keys

- Access the 'Perso' page.
- Find the caller you want to call from the programmed call keys.
- Call the chosen caller.

## 2.9 Filtering calls using the voice mailbox

This service lets you filter incoming calls to your voice mailbox. When your caller leaves his message you can choose to communicate with him.



### Activating call screening

- Voice mail filtering programmed key.
- Enter your personal password.
- Same key to stop listening and deactivate the screening.

### When you receive a call

You hear the message left by your caller.

Use one of the following:

-  or : Hands free to take the call.
- Lift the receiver to take the call.
- : To stop listening only.

This feature is accessible via a programmed key. The programmed key is generally created by the administrator during system configuration. You can program the key with the corresponding code managed by the administrator.





## 2.10 Redialing

### Redialing the last number dialed (redial)

-  (short press) >> Last number redial.

### Call back on the last 10 numbers dialed

-  (long press).
- Select the number to redial from the last 50 dialed numbers.
-  or  Start the call.

You can also access this feature through the menu:

- Reach the 'Menu' page.
- [Redial list](#)
- Select the number to redial from the last 50 dialed numbers.

## 2.11 Requesting automatic callback if internal number is busy

- Internal number busy.
- [Call back](#) >> Callback request acknowledged.
- 

Automatic callback is not available if the set of your caller is free or if you are put on hold when the set is busy.

## 2.12 Cancelling an automatic callback

- When your phone rings.
- [Call back](#) >> *Cancellation of callback request acknowledged.*

Canceling the callback request is only possible when the caller you tried to reach released the line.

## 2.13 Receiving intercom calls

You can answer a call without lifting the receiver. When you receive a call, you are automatically connected in hands-free mode. The identity of the caller is displayed on the screen.

### To activate-Terminal idle:

-  >> Corresponding LED lights up.

When your caller hangs up, interphony mode remains active.

### To deactivate-Terminal idle:

-  >> The corresponding LED goes out.

## 2.14 Sending DTMF signals

During a conversation you sometimes have to send DTMF signals, such as with a voice server, an automated attendant or a remotely consulted answering machine.



- During a conversation.
- *#MFcode*
- Enter DTMF code.
- *xSendMF*  
To deactivate the feature.

The function is automatically cancelled when you hang up.

## 2.15 Mute, so that your caller cannot hear you

You can hear your caller but he/she cannot hear you:

### From the set





- During a conversation.
-  Disable microphone >> The mute key blinks.
-  Resume the conversation >> The key is no longer lit.

## 2.16 Sending an instant message to a contact





**123<>abc** Use the alpha-numeric keyboard key to switch between the numeric and alphabetic keyboard.

You can send an instant message to a contact by entering either their phone number or their name.

### Sending an instant message using the search by name feature



-  Access the messaging portal (Enter your password if required).
- *SendIM*
- **123<>abc** Enter the first letters of the name.  
When entering the name you can extend the search by adding the first letters of the first name after entering the '#' symbol or pressing: *1stname*.
-  Start the search.
- A list of matching names is displayed on the screen. Each contact is displayed with their name and company phone number.
- Press the softkey associated with the contact name:  
The contact card opens and displays information about the contact: last name and first name, several phone numbers (Office, mobile, home), email address, instant message address and the company name.
- Scroll through the screen with the up and down navigation keys and position the cursor on the instant message address.
-  Access instant message writing mode.
- **123<>abc** Write the instant message to send.
-  Send the instant message.

## Sending an instant message using the phone number

-  Access the messaging portal.
- *SendIM*
- Enter your password if required.
- Enter your contact's phone number.
-  Access instant message writing mode.
-  Write the instant message to send.
-  Send the instant message.

## Status of the instant messages

Once the instant message has been sent, the message is stored in the 'Sent' tab of the instant message feature in the messaging portal. The status of the message is as follows:





	Instant message has been sent but not yet delivered.
	Instant message has been delivered.
	Instant message has been read.

## 2.17 Answering with an instant message



 Use the alpha-numeric keyboard key to switch between the numeric and alphabetic keyboard.

You can send instant messages to your contacts when you have received an instant message or a voicemail or you can send instant messages when consulting the call log.





## Answering an Instant message

-  Access the messaging portal.
- Select the instant message feature by pressing the associated softkey.
- Enter your password if required.
- Using the left and right navigation keys, access one of the following tabs: new messages, received messages, sent messages or all messages.
- Using the up and down navigation keys, position the cursor on the instant message you want to answer.
-  Select the instant message.
-  Answer the instant message by pressing the associated softkey.
-  Write the instant message to send.
-  Send the instant message.

## Answering a voice message





-  Access the messaging portal.
- Select the voicemail feature by pressing the associated softkey.
- Enter your password if required.
- Using the left and right navigation keys, access one of the following tabs: new voice messages or all voice messages.
- Using the up and down navigation keys, position the cursor on the voice message you want to answer with an instant message.
- When details of the voice message are displayed on the screen, press the softkey associated with the instant message.
-  Write the instant message to send.
-  Send the instant message.

## Answering from the call log

-  Access the messaging portal.
- Press the softkey associated with the call log feature.
- Enter your password if required.
- Using the left and right navigation keys, access one of the following tabs: missed calls or all calls.
- Using the up and down navigation keys, position the cursor on the call log you want to consult.
-  Select the call log.
- When details of the call log are displayed on the screen, press the softkey associated with the instant message feature.
-  Write the instant message to send.
-  Send the instant message.

## 2.18 Consulting instant messages

You are notified of a new event when the message key is flashing.



-  Access the messaging portal.
- Select the instant message feature by pressing the associated softkey.
- Enter your password if required.
- Using the left and right navigation keys, access one of the following tabs: new messages, received messages, sent messages or all messages.
- Using the up and down navigation keys, position the cursor on the instant message you want to read.
-  Select the instant message.
- Once the instant message is read, you can:
  -  ← Answer the instant message by pressing the associated softkey.
  -  Delete the instant message by pressing the associated key.
  -  Press OK to call the sender of the instant message.

When a message is read, the status of the message changes from unread to read on both sides (on the recipient side and the sender side).

You can use the filter key to consult messages sent by or to a particular contact. For example, when you are on a message sent by a contact, pressing the filter key shows only messages sent to or by that contact.



### Acknowledge new instant messages

Once a new instant message is read, it is automatically acknowledged. However, you can acknowledge all new instant messages without reading them.

-  Press the associated softkey.
-  Press the associated softkey.  
All new instant messages are acknowledged.

### Delete instant messages

When consulting the instant messages, you can choose to delete the messages stored in the following tabs: new, sent, received or all messages.

-  Press the associated softkey.
-  Press the associated softkey.
-  Confirm deletion.

## 3 During a conversation

### 3.1 Making a second call during a conversation

During a conversation.

- **Hold** Put the call on hold by selecting the “Hold” key.  
The first call is on hold.

Use one of the following:

- Dial directly the number for your call
- **123<>abc** Name of second caller.
-  (long press) or **C** › Menu page: *Redial list* › Select the No. in the last ten issued.
- **C** › Perso page › Select the programmed key.



#### Cancel your second call

Use one of the following:

- On hook the handset.
-  Hang up key (If in handsfree mode).

#### Recover the call on hold:

Use one of the following:

-  Press the key associated with the call on hold.
-  Hands free to take the call.
- Lift the receiver.
-  Start call key.

You are in conversation with your first caller again.

If you make an error, hang up: your telephone will ring and you will recover your first call.

## 3.2 Answering a second call during a conversation

- During a conversation, another person is trying to call you. The name or number of the caller is displayed for a few seconds.
- Use one of the following methods to answer the displayed call.
  - Line key for which icon is flashing .
  - *Queue* > *Answer*
- The first call is on hold.



### Cancel your second call

Use one of the following:

- On hook the handset.
-  Hang up key (If in handsfree mode).

### Recover the call on hold:

Use one of the following:

-  Press the key associated with the call on hold.
-  Hands free to take the call.
- Lift the receiver.
-  Start call key.

You are in conversation with your first caller again.

If you make an error, hang up: your telephone will ring and you will recover your first call.

## 3.3 Switching between calls (Broker call)

During a conversation, a second call is on hold.

To accept the second call:

-  Press the key associated with the call on hold >> Your first call is placed on hold.

## 3.4 Transferring a call

### To transfer your call to another number:

- During a conversation.
- **Transfer** Select the “transfer” key >> The first call is on hold.
- Calling a second person during a conversation
- You can transfer the call immediately or wait for your contact to answer before transferring the call.
- **Transfer** Perform the transfer.

Transfer between two outside calls is not generally possible (depends on country concerned and system configuration).

### 3.5 Transfer a call to a voice mail

During the call, you want to transfer your caller to the voice mailbox of another caller.

- *TrfVMU*
- Number of second caller.

### 3.6 Three-way conference with internal and/or external callers (conference)

- During a conversation, a second call is on hold.
- *xConfer* >> You are in conference mode.

#### Cancel the conference.

- *xConf*
- You can talk to the second caller and the first one is on hold.

#### Hang up on all caller

Use one of the following:



-  Hang up.
- On hook the handset.

#### After the conference, to leave your two callers talking together:

- *xConf*
- *Transfer*

### 3.7 Placing a call on hold (hold)

During a conversation, you wish to place the call on hold and recover it later, on the same telephone.

- During a conversation.
-  Put the call on hold by selecting the "Hold" key. .

Recover the call on hold:

-  Press the key associated with the call on hold.



### 3.8 Placing an outside call on hold (parking)

You can place an outside call on hold and recover the call on another telephone:

- During a conversation.
- *Park*

#### To recover the parked call:

- Reach the 'Menu' page.
- *Pickup* > *Unparkcall*

If the parked call is not recovered within a preset time (default value 1 min 30), it is transferred to the operator.

### 3.9 Intrusion into an internal conversation

Your caller's line is busy. If the number is not 'protected' and if authorised, you can intrude into the call:

- *xIntrusion*
- Same key to exit (*xIntrusion*)

#### Protection against intrusion:

- Press programmed key.
- Enter caller's number.

Protection is cancelled when you hang up.

The programmed key is generally created by the administrator during system configuration. You can program the key with the corresponding code managed by the administrator.

### 3.10 Store a number

During a call, to save the number onto a call key:

During a conversation.

- *Savetorep*
- Press a call key on the Perso page.
- Enter the name of your caller.
- Apply.

### 3.11 Adjust audio volume

During a call, to adjust the volume level of the loudspeaker or receiver:

- During a conversation.
-   Adjust audio volume.

## 4 'Meet me' conference

The 'Meet me' function is used to set up a conference with a maximum of 6 persons: the 'master' of the conference (who has the rights for initiating the conference) and the participants (maximum of 5) who meet for the conference.

### 4.1 Initiate a 'Meet me' conference

In order for the participants to join the conference, you must first decide on a meeting time for the conference and send them the access code.

- Lift the receiver.
- Enter the 'Meet me' conference activation code. This code is defined by the administrator during system configuration. If necessary you may need to contact your administrator.
- Enter your telephone number (internal).
- Enter your personal password.
- Enter the conference access code.

The conference is set-up. Participants must enter this access code to join the conference call. Send the conference call access code to the participants.

When the system prompts you to enter a code or password, you are allowed 3 attempts before the system rejects your request.

Call number for activating the 'Meet me' conference: this call number is used by the conference master when he wishes to initiate a conference from an external set. This number must have been defined previously by the system administrator.

### 4.2 Join a 'Meet me' conference

Once set-up by the conference master, the participants can join the 'Meet me' conference (5 participants maximum).

- Lift the receiver.
- Enter the joining code for the 'Meet me' conference. This code is defined by the administrator during system configuration. If necessary you may need to contact your administrator.
- Enter the conference access code.  
Conference access code: 4 digit code defined by the conference master and communicated to the participants so that they can join the conference.

You are in conference mode.

When the conference master on-hooks, all the communications will be cut-off.

Call number for joining the 'Meet me' conference: this call number allows the participants to join a conference from an external set.

An audible beep sounds when a participant joins the conference. 2 audible beeps sound when a participant leaves the conference.

You cannot join a conference if there are already the maximum number of participants.

If the conference has not yet been set up by the conference master you are put on hold until the conference is initiated (5 minutes maximum).

If you cannot directly reach the conference, you have to call first an internal user or an automatic operator. This one dials the call number for joining the 'Meet-me' conference and then transfers your call (10 seconds).

# 5 Sharing

## 5.1 Receiving supervised call ringing

To receive the special ringing for calls to another number:

- Supervised call ringing programmed key.
- Same key to cancel.

The programmed key is generally created by the administrator during system configuration. You can program the key with the corresponding code managed by the administrator.

## 5.2 Answering the general bell

When the operator is absent, outside calls to the operator are indicated by a general bell. To answer:

- Reach the 'Menu' page.
- *Pickup* › *GenBell*

## 5.3 Manager/Assistant filtering

System configuration allows 'Manager/Assistant' groups to be formed, so that the manager's calls can be directed to one or more assistants.

This feature is accessible via a programmed key. The programmed key is generally created by the administrator during system configuration. You can program the key with the corresponding code managed by the administrator.

### **From the manager or assistant telephone:**

- Filter programmed key ›› Incoming calls are filtered by a chosen person (assistant, etc.).
- Same key to cancel.

Filtering is indicated on the manager's telephone by the icon corresponding to the 'screening' programmed key.

## 5.4 Call pick-up

You hear a telephone ringing in an office where no-one can answer. If authorised, you can answer the call on your own telephone.

This feature is accessible via a programmed key. The programmed key is generally created by the administrator during system configuration. You can program the key with the corresponding code managed by the administrator.

### **If the telephone ringing is in your own pick-up group:**

- Group call pick-up programmed key.

### **If the telephone ringing is not in your pick-up group:**

- Reach the 'Menu' page.
- *Pickup* › *Set*
- Enter the number of the ringing telephone.

The system can be configured to prevent call pick-up on certain telephones.

**Outside calls to the operator will ring on your telephone and you can answer the call:**

- Operator help programmed key.
- Your telephone will ring at the same time as the switchboard.
- Same key to cancel.

**Calls to the switchboard:**

Calls to the switchboard will ring on your telephone.

- Lift the receiver.
- 
- Operator help programmed key.

## 5.5 Hunting groups

**Hunting group call:**

Certain numbers can form a hunting group and can be called by dialling the group number.

- Lift the receiver.
- No. of group to be called.

**Temporary exit from your hunting group:/Return into your group:**

- Leave group programmed key.
- Enter your group number.

Belonging to a group does not affect the management of direct calls. A specific telephone within a group can always be called by using its own number.

## 5.6 Calling an internal caller on his/her pager

This feature is accessible via a programmed key. The programmed key is generally created by the administrator during system configuration. You can program the key with the corresponding code managed by the administrator.

The number called does not answer and you know that the person called has a pager:

- Paging programmed key.
- Paging in progress is displayed.

Your caller can answer from any telephone in the system.

## 5.7 Answering a call on your pager

This feature is accessible via a programmed key. The programmed key is generally created by the administrator during system configuration. You can program the key with the corresponding code managed by the administrator.

A call on your pager can be answered from any telephone within the system.

Your pager beeps.

- Answer paging programmed key.
- Enter your group number.



## 5.8 Calling a caller on his/her loudspeaker

Your internal caller does not answer. If authorised, you can remotely activate your caller's phone:

- Your caller does not reply.
- *Interphony*

You are connected to the loudspeaker on your caller's phone (if he/she has the hands free function).





## 5.9 Send a voice message copy

-  Access the messaging portal.
- Press the softkey associated with the voice message feature.
- Enter your personal mailbox password.
- Using the left and right navigation keys, select the tab to consult (new or all messages).
- Using the up and down navigation keys, position the cursor on the voice message you want to send.
-  Select the message to send.
- *Sendcopy*
- Enter the destination number.
- 
- *Sendmessage*

When sending a copy of the message, you can also record a comment to join to the copy.

- *Record*
- Start recording the comment.
- *Stop*
- 

## 5.10 Sending a recorded message to a number or a distribution list

-  Access the messaging portal.
- Press the softkey associated with the voice message feature.
- Enter your personal mailbox password.
-  Press the associated softkey.
  - Enter the number of the recipient or select a destination list.
 or.
  -  Enter the name of the recipient using the alphapad.
- 
- *Record*
- Start recording the comment.
- *Stop*
-  Send the message.

## 5.11 Broadcasting a message on the loudspeakers of a station group

A message not requiring an answer can be broadcasted on the loudspeakers within your broadcast group:

- Off hook.
- Number of broadcast group >> Speak, you have 20 seconds.
-  / Hang up.

The message will only be broadcast on terminals not in use and which have a loudspeaker.

## 6 Keep in touch



### 6.1 Selecting calls to be forwarded

When a forward is applied, you can select the types of call to be forwarded: outside, internal, all.

-  Press the key associated to the forward icon.
- *Ext/Int* >> Select the type of Out/Int call >> type of call forwarded is displayed.
- *Allcalls* >> forward internal and outside calls.
- *External* >> Forward outside calls.
- *Internal* >> Forward internal calls.

### 6.2 Forwarding calls to another number (immediate forward)



The number can be your home, mobile, voice mailbox or an internal extension (operator, etc.).

-  Press the key associated to the forward icon.
- *Immediat*
- Number to be called >> Forward is acknowledged.
- 

You can also select the destination number of the forward through the redial feature or the individual repertory.



You can make calls, but only the destination number can call you.

### 6.3 Forwarding your calls to your voice message service

-  Press the key associated to the forward icon.
- *Immed'VM* >> Forward is acknowledged.
- 



### 6.4 When you return, consult recorded messages

You are notified of a new event when the message key is flashing.

-  Access the messaging portal.
- Press the softkey associated with the voice message feature.
- Enter your personal mailbox password.
- Using the left and right navigation keys select the new voice messages tab.
- Using the up and down navigation keys position the cursor on the message you want to listen to.
-  Select the message to listen to.  
Display name of sender, with date, time and ranking of message.
- *Play* >> Listen to message.
- *Clear* >> Erase message.
- *Call* >> Call back sender of message.
- *Sendcopy* >> Copy message.
- *SendIM* >> Send an instant message.

## Acknowledge all new voice messages

Once you start listening to a voice message, the message is automatically acknowledged. However, you can acknowledge voice messages without listening to them.

-  Press the associated softkey.
-  Press the associated softkey.
- 

## 6.5 Activate/disable the personal assistant

- Reach the 'Menu' page.
- *Settings* > *Assistant*
- *On* or *Off* >> Activate or deactivate the assistant.
- 

## 6.6 Personal assistant: reaching you with one number only

- Reach the 'Menu' page.
- *Settings* > *Assistant* > *Menu*
- You can then choose where to route the calls:
  - *InternNr* >> Dial number of a colleague or your assistant.
  - *ExternNr* >> Dial an outside line number.
  - *MobileNr* >> Dial number of your mobile or DECT.
  - *Operator* >> Activate/deactivate transfer to operator.
- 

## 6.7 Forwarding calls to your pager

Callers will thus be able to contact you while you are moving around the company:

-  Press the key associated to the forward icon.
- *Topaging* >> Forward is acknowledged.



## 6.8 Forwarding your calls from the receiving terminal ('Follow me')

You wish to receive your calls in your present location:

Use the 'Follow me' function.

-  Press the key associated to the forward icon.
- *Followme*
- Dial your extension number >> Forward is acknowledged.

If you have a key programmed with this feature, you can access the feature directly.

- Press programmed key.
- Dial your extension number >> Forward is acknowledged.

## 6.9 Diverting all group calls

You can forward all your group calls to another internal number:

- Group calls forwarding programmed key.
- Enter the destination number.
- Forward is acknowledged.

## 6.10 Cancelling all forwards

-  Press the key associated to the forward icon.
- *Cancfwd*

To cancel all forwards, you can programme another type of forward too

## 6.11 Cancelling a specific forward

- Programmed key corresponding to type of forward (group or selective).

## 6.12 Forwarding calls when your line is busy (forward if busy)

Callers can be forwarded to another telephone if you are already on the line.

-  Press the key associated to the forward icon.
- *Onbusy*
- Enter the destination number >> Forward is acknowledged.

## 6.13 Do not disturb

You can make your terminal temporarily unavailable for all calls.

-  Press the key associated to the forward icon.
- **DND >>** Forward is acknowledged.

Callers wishing to contact you will see the 'Do Not Disturb' message displayed on their sets when they try to call.

## 6.14 Leaving a recorded message for internal callers

You can leave a message on your terminal which will be displayed on the screen of the terminal calling you.

-  Press the key associated to the forward icon.
- **Textansw**
- Choose the type of message.

### Sending predefined message

- **FixedMsg**
- Select the message to be sent.
- 

Enter the number of the ringing telephone *Language*.

Notice that you can select the message to send by its number by selecting the option: *Gotomessage*.

The 27 standard messages are shown below:



1	Call me back	15	Meeting on ____ (*)
2	Call me back tomorrow	16	Meeting on ____ at _:_ (*)
3	Call me back at _:_ (*)	17	Out for a while
4	Call back _____ (*)	18	Absent for the rest of the day
5	Call the attendant	19	Absent, back at _:_ (*)
6	Call the assistant	20	Absent, back on ____ at _:_ (*)
7	I will call back at _:_ (*)	21	On vacation, back on ____ (*)
8	Use paging	22	External meeting
9	Please fetch your fax	23	External meeting, back on ____ (*)
10	Please fetch your mail	24	I am in room nr ____ (*)
11	Please cancel your forwarding	25	In a meeting - do not disturb
12	Visitors are waiting	26	At lunch
13	You are expected at reception	27	Indisposed
14	Meeting at _:_ (*)	(*)	Messages to be completed using numeric keypad

### Sending a new message

- **NewMsg**
- Write your message.
- 

## 6.15 Consulting written messages

The light indicates that messages have been received.

-  » Number of messages received.
- *ReadTxtMsg* » Displays the sender's message on the screen.
- *Readmore* » Displays the rest of the message and the date and time it was left.
- Display name of sender, with date, time and ranking of message.
  - Use the left-right navigator to see previous and next messages.
  - *Clear* » Erase message.
  - *Call* » Call back sender of message.
  - *SendTxtMsg* » *Sending a written message to an internal caller.*
  - *Savetorep* » Save the sender's number in your directory.
  -  » Terminate consultation.

## 6.16 Message notification

A message is left in your mailbox but you are not at your desk. You can configure your telephone so that you receive notification of the message on another telephone.

- Reach the 'Menu' page.
- *Settings* » *Notification*
- Press consecutively to activate/deactivate.
- *ON/OFF*
- *Choice* » Press consecutively to activate/deactivate.
- 

### Change the time slot

The time slot during which notification is activated can be changed.

- *Schedule*
- Change times.
- 

# 7 Programming your telephone

## 7.1 Initializing your voice mailbox

- Light flashes.
- 
- Enter your personal code then record your name according to voice guide instructions.

Your personal code is used to access your voice mailbox and to lock your telephone.

Your password has 6 digits. A weak personal code with 6 identical digits (000000, 111111, etc.) or a simple sequence of 6 digits (012345, 123456, etc.) will be rejected by the system. After a system upgrade, the password may still have only 4 digits. For security reasons, we recommend you use a password with 6 digits. Contact your installer for more information. The list of weak passwords provided does not contain all the possibilities.

## 7.2 Customizing your voice greeting

You can replace the greeting message by a personal message.

- Reach the 'Menu' page.
- [Settings](#) › [Mailbox](#)
- You can listen to the greeting, customize the greeting and set the default greeting ([Listen](#), [Rename](#), [Default](#))
- You can replace the greeting message by a personal message ([Persomsg](#)).
- You can pause, resume or stop the recording at any time.

## 7.3 Modifying your personal code

- Reach the 'Menu' page.
- [Settings](#) › [Options](#) › [Password](#)
- Old code (6 digits).
- New code (6 digits).
- 



Until your voice mailbox is activated, the default password is defined by the administrator.

Your password has 6 digits. A weak personal code with 6 identical digits (000000, 111111, etc.) or a simple sequence of 6 digits (012345, 123456, etc.) will be rejected by the system. After a system upgrade, the password may still have only 4 digits. For security reasons, we recommend you use a password with 6 digits. Contact your installer for more information. The list of weak passwords provided does not contain all the possibilities.





## 7.4 Adjusting the audio functions

- Reach the 'Menu' page.
- [Settings](#) › [Phone](#) › [Ringing](#)



### Choose the tune

- [Int. Melody/Ext. Melody](#)  
The tune must be chosen for external and internal calls.
- Select the melody of your choice (16 tunes).
- 
-  End.



### Adjusting the ringer volume

- [Volume](#)
-   Select the volume you want: (10 levels).
- 
-  End.



### Activate/deactivate silent mode

- [Silent](#)
- [ON/OFF](#) ›› activate/deactivate.
- 
-  End.



### Activate/deactivate meeting mode (progressive ringing)

- [Progress](#).
- [ON/OFF](#) ›› activate/deactivate.
- 
-  End.

### Activate/deactivate discreet ring mode

- [Beeps](#)
- [ON/OFF](#) ›› activate/deactivate.
- 
-  End.

### Adjust ringer volume while a call arrives





- Your telephone rings.
-   Adjusting the ringer volume.

## 7.5 Adjusting the contrast of the display





- Reach the 'Menu' page.
- [Settings](#) › [Phone](#) › [Contrast](#)
- [Screen](#) or [Keys](#) ›› Increase or reduce the brightness of the screen or keys (of the extension unit) by pressing consecutively on the corresponding keys.
- 

## 7.6 Selecting the welcome page

This function is used to choose the page displayed by default on the telephone.



- [Settings](#) › [Options](#) › [Homepage](#)
-   Select the default page.
- 
- 

## 7.7 Selecting language

- Reach the 'Menu' page.
- [Settings](#) › [Options](#) › [Language](#)
-   Select the language of your choice.
- 
- 



## 7.8 Program the keys for the Perso page

You can program keys of the perso page.

- Access the Perso page using the navigator.
- If the key is not programmed yet:
  - Select the key to program.
  - [Name](#)
  - Enter the name to associate with the key.
  - 
  - [Number](#)
  - Enter the number to associate with the key.
  - 
  - 

## 7.9 Programming direct call keys (programmed keys with LEDs)

The phone has four programmed keys with LEDs and a phone label.



- Press a programmable key if the key is not programmed yet.
- [Name](#)
- Enter the name to associate with the key.
- 
- [Number](#)
- Enter the number to associate with the key.
- 
- 

Write name of the key on the phone label.



## 7.10 Modify the programmed key

- Reach the 'Menu' page.
- [Settings](#) > [Keys](#)

### Modify a programmed direct call keys (programmed keys with Leds)

- Select the programmed key to modify.
- [Name](#)
- Enter the name to associate with the key.
- 
- [Number](#)
- Enter the number to associate with the key.
- 
- 



### Modify a programmed key on perso page

- [Prog perso page](#)
- Access the 'perso ' page if necessary.
- Select the programmed key to modify.
- [Name](#)
- Enter the name to associate with the key.
- 
- [Number](#)
- Enter the number to associate with the key.
- 
- 



## 7.11 Delete a programmed key

- Reach the 'Menu' page.
- [Settings](#) > [Keys](#)

### Delete a programmed direct call keys (programmed keys with Leds)

- Select the key to delete.
- [Clear](#)
- 
- 

### Delete a programmed key on perso page

- Select the key to delete.
- [Clear](#)
- 
- 

## 7.12 Programming an appointment reminder

You can set the time of a temporary reminder (one within 24 hours) or a permanent reminder (every day at the same time).

- Reach the 'Menu' page.
- *Appointmt*
- Enter time of appointment.
- *Temporary/ Permanent* >> Select the type of appointment (temporary or permanent).
- 

 The 'Appointment programmed' icon is displayed on the welcome page.

**At the programmed time, your phone rings:**

- 

If your calls are forwarded to another terminal, the forward is not applied to the reminder call.

**To cancel your reminder request:**

- Reach the 'Menu' page.
- *Appointmt*
- *Temporary/ Permanent* >> Select the type of appointment (temporary or permanent).
- *Clear*
- 

The 'Appointment programmed' icon disappears from the welcome page.

## 7.13 Identify the terminal you are on

The number of your telephone is displayed on the 'Info' page.

## 7.14 Lock / unlock your telephone

 This icon indicates that the phone is locked.

- Reach the 'Menu' page.
- *Lock*
- Enter your password >> Your telephone is locked/unlocked.

## 7.15 Activating/Deactivating 'Forced headset' mode

- Reach the 'Menu' page.
- *Settings* > *Phone* > *FcedHead*
- *ON/OFF* >> activating/deactivating forced headset.



## 7.16 Install a USB accessory (Headset, Handsfree, Loudspeaker)

- Connect the accessory to the USB connector.
- When you plug the accessory in the USB port, the USB accessory is automatically detected. If necessary, you can also select the accessory type in the audio settings:
- Reach the 'Menu' page.
- [Settings](#) › [Phone](#) › [USB](#)
- Select the type of device connected to the USB.
  - [Headset](#)
  - [Handsfree](#)
  - [Ldspeaker](#)

This feature can be deactivated by the administrator.

## 7.17 Configure your phone for teleworking

Your IP phone is compatible with teleworking (VPN) via a secure connection (encrypted). In this mode, all features available at your office will be ready for use remotely.

If the telephone system of your enterprise is configured to accept remote workers (system and infrastructure), you have to configure your deskphone to be ready for teleworking. Your installer has to give you all information to configure your deskphone.

You have to:

- Enable VPN.
- Enter the remote VPN server information.
- Enter the TFTP server information (optional).
- Enter authentication.
- Setup the VPN start preferences.

### 7.17.1 First connection as teleworking



When you connect your deskphone for the first time remotely, you are prompted to set a PIN code.

The PIN code is requested when you enter in the VPN configuration (submenus) or when you boot your deskphone (depending on the VPN configuration).

The PIN code is retained during the session so that you can access the VPN configuration without having to re-enter your PIN code until you exit the VPN configuration.

Before configuring your phone for teleworking, check if you have all the information from your administrator.

To configure your deskphone:

- Connect your deskphone to the network (and plug in the power jack if you are using an external power adapter).
- When the deskphone displays the 'Step 2' during the boot, repeatedly press the '\*' and '#' keys in succession until a menu is displayed.
- **VPN** (Scroll down the menu).
  - **VPN Config**
    - Enter the new PIN Code.
    - Validate.
    - **123<>abc**: Switch the keyboard to the alphabetic mode when you have to enter text.
    - **Enable VPN**: you have to activate this option to use your deskphone for teleworking.
    - **Server**: enter the address of the VPN server.
    - **PSK**: enter the pre-shared key to establish a secure connection with the VPN server. The PSK can be unique for all remote workers on a same installation or can be specific to each remote worker. In the first case, the VPN authentication has to be enabled.
  - **VPN Tftp** › **Use TFTP servers, tftp1, tftp2,port**: if the TFTP servers are required, activate this option and enter the addresses and port of the TFTP servers.
  - **VPN Auth** › **Use Authentication, User, Pass**: activate this option if a logon to the VPN server (username and password) is required. The VPN authentication can be disabled in case a specific PSK is used for each remote worker.
  - **VPN Pincod** › **Request Pin on Boot**: if this option is activated, the PIN code is required when you boot your deskphone. We recommend you activate this option.
  -  Select this icon to return to the main menu.
  - Select this icon to save parameters.
- The VPN configuration is saved and the main menu is displayed.
-  select this icon to exit the configuration menu. The deskphone restarts.
- Enter the PIN code if you have selected the option (**Request Pin on Boot**).
- Validate.
- Your deskphone is ready for teleworking.

If you leave the PIN code request menu when the phone is starting, the phone will start without VPN activated.

### 7.17.2 Change the configuration

You have to change a parameter of the VPN configuration.

- Restart the deskphone (unplug and plug in the power jack if you are using an external power adapter or the Ethernet connector – LAN).
- When the deskphone displays the 'Step 2' during the boot, repeatedly press the '\*' and '#' keys in succession until a menu is displayed.
- *VPN* (Scroll down the menu).
- Select a submenu to change the configuration (*VPN Config*, *VPN Tftp*, *VPN Auth*, *VPN Pincod*).
- Enter your PIN code (if an administrator password is defined by the system, you can use it to access to the VPN configuration by selecting: *Use Password*).
- Validate.
- Change parameters (`123<>abc`): Switch the keyboard to the alphabetic mode when you have to enter text).
- Select this icon to save parameters.
- The VPN configuration is saved and the main menu is displayed.
-  select this icon to exit the configuration menu. The deskphone restarts.
- Enter the PIN code if you have selected the option (*Request Pin on Boot*).
- Validate.
- Your deskphone is ready for teleworking.

### 7.17.3 PIN code

The PIN code is composed of 4 digits. You can access the VPN configuration by entering the PIN code or the administrator password if defined by the system. Depending on the VPN configuration, the PIN code is requested when you boot your deskphone. We recommend you enable this option for security reasons and if you need your phone in remote and in business place (See 7.17.5 Reconnect your deskphone in your business place).

If the PIN code is incorrect 5 times in succession, the PIN code and VPN parameters will be erased.



If no administrator password is defined by the system, the PIN code is required to access VPN configuration.

### 7.17.4 Reset your PIN code

- Restart the deskphone (unplug and plug in the power jack if you are using an external power adapter or the Ethernet connector – LAN).
- When the deskphone displays the 'Step 2' during the boot, repeatedly press the '\*' and '#' keys in succession until a menu is displayed.
- *VPN* (Scroll down the menu).
- *VPN Pincod*
- Enter your PIN code.
- Validate.
- *Set new Pincod*: enter the new PIN Code.
- Select this icon to save parameters.
- The VPN configuration is saved and the main menu is displayed.
-  select this icon to exit the configuration menu. The deskphone restarts.
- Enter the PIN code if you have selected the option (*Request Pin on Boot*).

### 7.17.5 Reconnect your deskphone in your business place

Your phone is already configured for teleworking.

- Connect your deskphone to the network (and plug in the power jack if you are using an external power adapter).
- If the option to enter PIN code when you boot your deskphone is enabled in the VPN configuration (*Request Pin on Boot*):
  - The PIN code is requested.
  -  Select this icon to go back.
  - The phone restarts in normal mode. The VPN is temporary disabled until the next reboot.
- If the option is not enabled:
  - When the deskphone displays the 'Step 2' during the boot, repeatedly press the '\*' and '#' keys in succession until a menu is displayed.
  - *VPN* > *VPN Config*
  - Enter your PIN code.
  - Validate.
  - *Enable VPN*: Disable the teleworker.
  - Select this icon to save parameters.
  - The VPN configuration is saved and the main menu is displayed.
  -  select this icon to exit the configuration menu.
  - The phone restarts in normal mode.

### 7.17.6 Reconnect your deskphone in remote place

Your phone is already configured for teleworking but it was connected in your place of business. You need to reconnect it in a remote place.

- Connect your deskphone to the network (and plug in the power jack if you are using an external power adapter).
- If the option to enter PIN code when you boot your deskphone is enabled in the VPN configuration (*Request Pin on Boot*):
  - The PIN code is requested.
  - Enter PIN code.
  - Validate.
  - The phone starts as teleworker.
- If the option is not enabled (*Request Pin on Boot*).
  - When the deskphone displays the 'Step 2' during the boot, repeatedly press the '\*' and '#' keys in succession until a menu is displayed.
  - *VPN* > *VPN Config*
  - Enter your PIN code.
  - Validate.
  - *Enable VPN*: Enable the teleworker.
  - Select this icon to save parameters.
  - The VPN configuration is saved and the main menu is displayed.
  -  select this icon to exit the configuration menu.
  - The phone starts as teleworker.

## 7.18 Contacting your administrator

If necessary you may need to contact your administrator.

Before contacting your administrator make sure you have information such as your phone's part number and software version to hand.

### **The part number**

The phone's part number is located under the foot of the phone.

### **Software version**

The software version can be viewed on the phone by following this path:

- *System* > *SWVersion*

## 8 ACD: Agent set/ Supervisor station

### 8.1 Agent set

A call center solution allows optimum distribution of calls to agents according to their availability and skills.

### 8.2 Open an agent session (login) – Agent set

- Select the ACD application.
- *Login*
- Select the agent and validate.
- 
- Depending the displayed information, enter your password or confirm.

» ACD application welcome screen is displayed.

### 8.3 ACD application welcome screen – Agent set

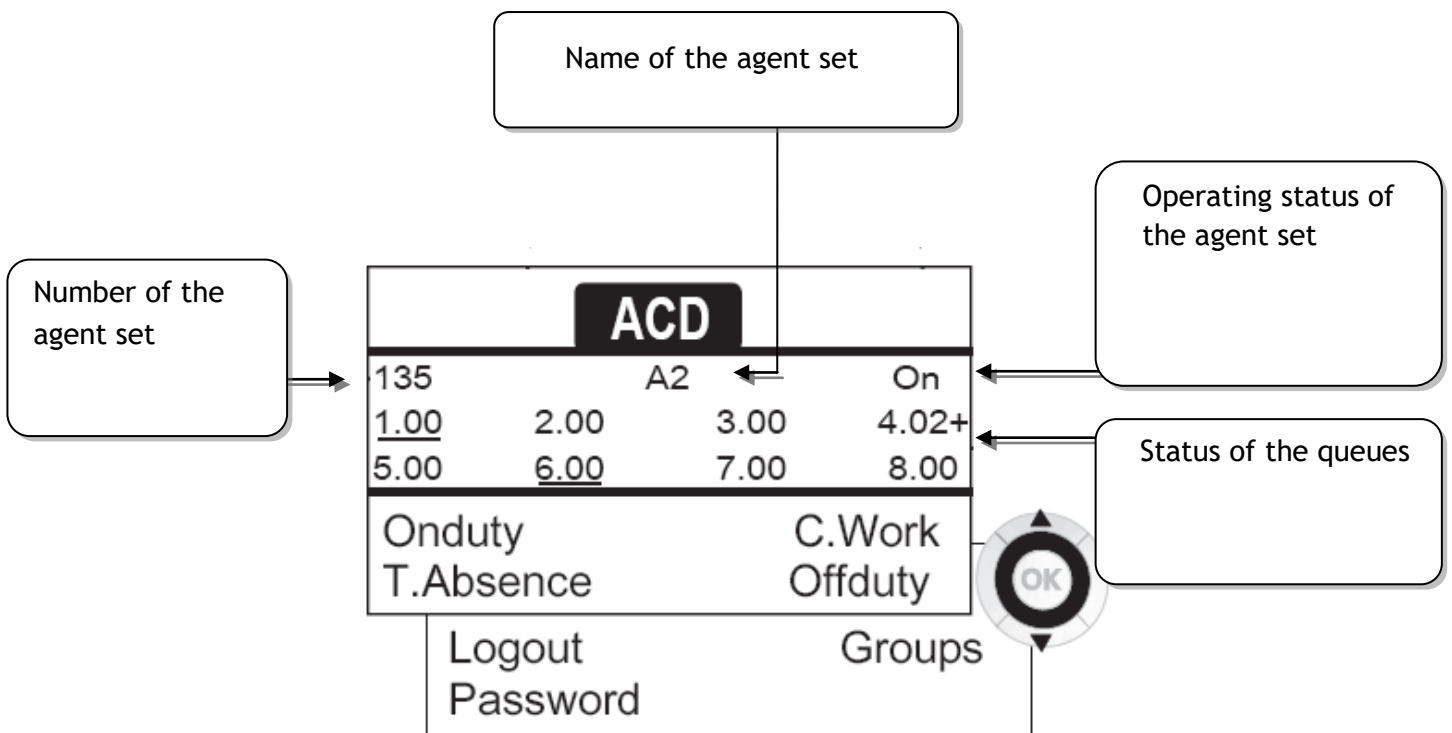

4.02 means: group number 4, 2 calls waiting, the + sign indicates that the queue capacity has been reached.

## 8.4 The four operating statuses of the agent set

An agent's availability is determined by the operating status (of which there are 4), that the agent can change at any time. These statuses are:

- *Onduty* >> In service, the agent is ready to receive calls.
- *Offduty* >> Withdrawn, the agent has withdrawn from the ACD application.
- *C.Work* >> Additional task, the agent is performing a task concerning a call and is not taking other calls.
- *T.Absence* >> Temporarily absent, the agent has taken a break and is not taking calls.

The agent can change the operating status directly by entering codes, pressing the function keys, or using the Agent Assistant agent software on PC (if available).

## 8.5 Changing the operating status of the set – Agent set

### Changing using codes (all sets)

The operating status change codes are defined when the system is configured. Contact the system administrator to obtain these codes.

- Enter the feature code to activate.

### Change using function keys

- Press the function key of the status to be activated. Information relative to the selected status is displayed on the screen. If a refusal message is displayed, contact the system administrator.

## 8.6 Modifying your personal code – Agent set

- *Password*
- New code (6 digits).

## 8.7 Integrating another group/leaving a group – Agent set

- *Groups*
- Press the key of the group (1 to 8) to integrate (box empty) and/or press the key of the group to leave (box full).

## 8.8 Close the agent session (logout) – Agent set

- *Logout*

## 8.9 Supervisor station

- A supervisor can consult the messages left in the voicemail inboxes of the call center groups (maximum 8 groups) using the function keys.

A supervisor can also perform the agent function from the same set.

## 8.10 Supervising group mailboxes – Supervisor station

### Consulting the messages:

When a message is left in a group mailbox, the voice mail present indicator associated with the supervision key flashes.

- Press the supervision key.
- Follow the instructions of the voice guide.

When a mailbox is consulted by a supervisor, the other supervisors cannot access it.

### Supervision keys for group mailboxes and positioning on the sets:

- Access the Perso page to display the positioning of the supervision keys on the sets.



# 9 Guarantee and clauses

---

## 9.1 Safety Instructions

- Changes or modifications to the equipment not expressly approved by the party responsible for compliance could void the user's authority to operate the equipment.
- Magnets could affect the functioning of pacemakers and implanted heart defibrillators. Keep a safe distance between your pacemaker or implant defibrillator and the handset which includes magnetic elements: 4 centimeters (1,6 inches) at least.
- To limit the risk of interference, people with pacemakers must keep the wireless telephone away from their equipment (minimum distance of 15 cm/6 inches).
- It is recommended to follow the standard acceptance procedures before using this equipment in human safety critical areas (hospitals...).
- The handset includes magnetic elements that may attract sharp metallic objects. To prevent injury, before each use ensure sharp metallic objects are not stuck to the earpiece and microphone.
- Avoid using phones (other than cordless type) during an electrical storm. There may be a remote risk of electric shock from lightning.
- Do not use the device in environments where there is a danger of explosion.
- Do not plug this phone into an Integrated Services Digital Network (ISDN) connection or into a regular Public Switched Telephone Network (PSTN) connection. This can result in severe damage to the phone.
- Never allow your telephone to come into contact with water.
- To clean your telephone, use a soft damp cloth. Never use solvents (trichlorethylene, acetone, etc.) which may damage the plastic parts of your telephone. Do not use aerosol cleaners.
- This product is intended to be supplied, either via the Ethernet (LAN) port, or via the DC-in by a Certified Direct Plug-In Power Unit approved as 'LPS' (Limited Power Source) against CSA/UL/IEC 60950-1 and rated 48V dc, minimum 0.27A. Allowed power supplies: WA-13B48R – Asian Power Devices Inc.
- If you are connected to a POE connection do not use an external Power Supply.
- The cover of the phone screen is made of glass. This glass could break if the phone is dropped or it receives a significant blow. If the glass chips or cracks, stop using the phone and do not touch the broken glass as this could cause injury to you. Glass cracked due to misuse or abuse is not covered under the warranty.

## 9.2 Regulatory Statements

### EUROPE

this equipment is in compliance with the essential requirements of following directives:

- Ecodesign Directive 2009/125/EC (ErP).
- Directive 2011/65/UE (ROHS).
- Electromagnetic Compatibility Directive (EMC) 2014/30/EU.
- Low Voltage Directive (LVD) 2014/35/EU.

Declaration of Conformity may be obtained from:

ALE International 32 avenue Kléber – 92700 Colombes, France  
ebg\_global\_supportcenter@al-enterprise.com

### USA and Canada

Operation is subject to the following two conditions: (1) this device may not cause harmful interference, and (2) this device must accept any interference received, including interference that may cause undesired operation. This equipment has been tested and found to comply with the limits for a class B digital device, pursuant to Part 15 of the FCC Rules. These limits are designed to provide reasonable protection against harmful interference in a residential installation. This equipment generates, uses and can radiate radio frequency energy and, if not installed and used in accordance with the instructions, may cause harmful interference to radio communications. However, there is no guarantee that interference will not occur in a particular installation. If this equipment does cause harmful interference to radio or television reception, which can be determined by turning the equipment off and on, the user is encouraged to try correcting the interference by consulting the dealer.

#### Exposure to Radio Frequency Signals.

This equipment complies with radiation exposure limits set by FCC/IC and the European Council. This equipment has very low levels of RF energy and is deemed to be compliant without testing of the specific absorption rate (SAR).

#### User Instructions

Only use the handset in temperatures between -5°C to +45°C (23°F to 113°F).

This product is intended for use in an indoor environment only. This apparatus is Hearing Aid Compatible (HAC).

#### Acoustic shock protection

Maximum sound pressure level for handset is compliant with European, US and Australian standards.

#### Directive 2003/10/EC specifying the risks inherent in noise at work

The ring contributes towards overall daily noise - at its maximum setting, the level is 105 dBA at 60 cm from terminal. To reduce the level, the following is recommended:- reduce the setting (9 levels of 5 dB) - program a progressive ring.

#### Privacy

Privacy of communications may not be ensured when using the Bluetooth® handset or any additional Bluetooth® device.



#### Disposal

The equipment must be returned to a collection point for electronic equipment waste disposal. Defective batteries must be returned to a collection point for chemical waste disposal.

#### Related Documentation

Other languages for these Safety and Regulatory Instructions and User Documentation are available at the following Web site: <http://enterprise.alcatel-lucent.com?product=All&page=Directory>.

The information presented is subject to change without notice. ALE International assumes no responsibility for inaccuracies contained herein. Copyright© ALE International 2017.



**LED**

- Flashing blue: Arrival of a new call / Appointment alarm

Features keys	
Mute and intercom key. During a call, press this key to stop your contact from hearing you. When idle, press this key to switch the phone to intercom mode. When you receive a call, the phone hooks off automatically and you go straight into handsfree mode. This key lights up blue when activated.	
Turn down the volume / Lower the contrast.	
Turn up the volume / Increase the contrast.	
Pressing this key answers an incoming call in handsfree mode (the key is blue). When a call is in progress, pressing this key switches from handsfree mode to headset or handset mode. The hands-free mode can be deactivated by the administrator.	
Messaging key to access various mail services. This key flashes when you have a new event (voicemail, text message or callback request) and stays lit until all events have been acknowledged or deleted. Access the call log.	
The redial key is associated with the off hook key when the phone is in idle state. <ul style="list-style-type: none"> <li>• Last number redial (short press).</li> <li>• Call back one of the last 8 numbers dialed (long press).</li> </ul>	

**Welcome screens**

You can access all of your phone's features from these screens. The default display has three pages that you can access by selecting the corresponding tab at the top of the screen with the navigation keys. The selected page is highlighted.

- Menu page: Contains all functions and applications accessible via the keys associated with the words on the screen.
- Perso page: Contains call line keys (allowing supervision of calls) and programmable call keys.
- Info page: Contains information on the telephone and the status of its functions: name, telephone number, number of messages, activation of transfer function, appointment reminder, etc.
- Transfer icon: Press the key next to this icon allows you to program or change the transfer function.

**Navigation**



**OK key:**

- Use to validate your choices and options while programming or configuring.
- Use to validate an edited text.
- Use to switch off/on the screen when the phone is in idle mode.

**Left-right navigator:**

- Use to move from one page to another and display information about current calls (call in progress, calls on hold, incoming call).
- Use to navigate into a text box.

**Up-down navigator:**

- Use to scroll through the content of a page.



**Back/Exit/Backspace key:**

- Use this key to go back to the previous step.
- Use this key to go back to the homepage (long press).
- Use this key to delete one number or character at a time.

**Status icons/ Call icons**

	Headset connected.		Incoming call icon.
	Telephone locked.		Call in progress icon.
	Appointment programmed.		Call holding icon.

**Preprogrammed keys**









The 8018 DeskPhone uses 3 preprogrammed keys to access some features. In this case, the icon of the feature is printed on the paper. Use the feature by pressing the corresponding key. When activated, the LED corresponding to the key remains lit up. Press the corresponding key to deactivate it.







- **123<->abc** Alpha-numerical keypad  
Use this key to switch between alphabetic keyboard and numeric keyboard.
- **Hold** Use this key to put the call on hold.
- **Transfer** Use this key to transfer a call...





**Alphabetic keypad**

- **123<->abc** Switch the keyboard to the alphabetic mode by selecting the associated programmed key. When activated, the LED corresponding to the key remains lit up.
- Enter alphabetic characters.  
The number pad keys have letters that you can display by successive presses. The number is the last character in the series. Some special characters can be displayed by successively pressing the key:

<b>*</b>	% \$ / ~ & ( ) [ ] = *
<b>#</b>	@ #
<b>1</b>	space - _ 1
<b>0</b>	+ . , ; : / \ ? ! 0

<p><b>Call</b></p> <ul style="list-style-type: none"> <li>Dial the number directly or dial the number after pressing a line key (an off-hook key or hands-free key).</li> </ul>	
<p><b>Call by name (Company directory)</b></p> <ul style="list-style-type: none"> <li><b>123&lt;&gt;abc</b> Switch the keyboard to the alphabetic mode by selecting the associated programmed key.</li> <li>Enter the first letters of the name.</li> </ul>	
<p><b>Answer a call</b></p> <ul style="list-style-type: none"> <li>Take the handset off the hook, use an off-hook key, the hands-free key, or press the key next to the incoming call icon.</li> </ul>	
<p><b>Ignore call / End the call</b></p>	
<p><b>Redial</b></p> <ul style="list-style-type: none"> <li>Long press to access the list of the last 10 dialed numbers.</li> <li>Short press to call the last dialed number.</li> </ul>	
<p><b>Make a call-back request to a busy number</b></p> <ul style="list-style-type: none"> <li><i>Callback</i></li> </ul>	
<p><b>Placing a call on hold (hold)</b></p>	
<p><b>Sending DTMF signals</b></p> <ul style="list-style-type: none"> <li><i>#MFcode</i></li> <li>Send numbers.</li> </ul>	
<p><b>Mute</b></p>	
<p><b>Interphony</b></p> <ul style="list-style-type: none"> <li>The phone automatically answers the call.</li> <li>Before the line is taken, you hear a succession of specific beeps.</li> </ul>	
<p><b>Making a second call during a conversation</b></p> <ul style="list-style-type: none"> <li><b>Hold</b></li> <li>Call the second contact</li> </ul>	
<p><b>Answering a second call during a conversation</b></p> <ul style="list-style-type: none"> <li>Press the key associated with the incoming call.</li> </ul>	

<p><b>Switching between calls (Broker call)</b></p> <ul style="list-style-type: none"> <li>Press the key associated with the call on hold.</li> </ul>	
<p><b>To cancel your second call and recover the first:</b></p> <ul style="list-style-type: none"> <li>You automatically recover the first call.</li> </ul>	
<p><b>Transferring a call</b></p> <ul style="list-style-type: none"> <li>You are in conversation with one caller.</li> <li><b>Transfer</b> Call a second contact.</li> <li><b>Transfer</b> Transfer the call.</li> </ul>	
<p><b>Conference</b></p> <ul style="list-style-type: none"> <li>Call the first contact.</li> <li>Call the second contact.</li> <li><i>#Confer</i></li> </ul>	
<p><b>Make calls via your programmed call keys</b></p> <ul style="list-style-type: none"> <li>Press the desired programmed call key.</li> </ul>	Perso
<p><b>Modify the programmed key</b></p> <ul style="list-style-type: none"> <li><i>Settings</i> &gt; <i>Keys</i></li> <li>Press the programmed key to be modified.</li> <li>Follow the on-screen instructions.</li> </ul>	Perso
<p><b>Erase a programmed key</b></p> <ul style="list-style-type: none"> <li><i>Settings</i> &gt; <i>Keys</i></li> <li>Select the key to be erased.</li> <li>Follow the on-screen instructions.</li> </ul>	Menu
<p><b>Customizing your voice greeting</b></p> <ul style="list-style-type: none"> <li><i>Settings</i></li> <li><i>Mailbox</i></li> <li>You can listen to the greeting, customize the greeting and set the default greeting.</li> </ul>	Menu
<p><b>Consulting your voice mailbox</b></p>	
<p><b>Diverting calls to your voice mailbox</b></p> <ul style="list-style-type: none"> <li>Press the key associated to the forward icon.</li> <li><i>Immed</i> VM</li> <li>Press the key associated with the type of call forward required.</li> </ul>	
<p><b>Cancel forward</b></p> <ul style="list-style-type: none"> <li>Press the key associated to the forward icon.</li> <li><i>Cancel</i> fwd.</li> </ul>	

<p><b>Do not disturb</b></p> <ul style="list-style-type: none"> <li>Press the key associated to the forward icon.</li> <li><i>DND</i></li> </ul>	
<p><b>Send text messages</b></p> <ul style="list-style-type: none"> <li><i>Message</i></li> <li><i>SendTxtMsg</i></li> <li>Enter the destination number.</li> <li>Select the type of message to send (fixed Msg, New Msg,...).</li> <li><b>123&lt;&gt;abc</b> You can switch between numeric keyboard to dial number, and alphabetic keyboard to enter text by pressing the corresponding programmed key.</li> </ul>	
<p><b>Read text messages</b></p> <ul style="list-style-type: none"> <li><i>Message</i></li> <li><i>ReadTxtMsg</i></li> </ul>	
<p><b>Information about the phone</b></p>	Info
<p><b>Lock/unlock the phone</b></p> <ul style="list-style-type: none"> <li><i>Lock</i></li> </ul>	Menu
<p><b>Adjust audio volume</b></p>	
<p><b>Select the language of your choice</b></p> <ul style="list-style-type: none"> <li><i>Settings</i> &gt; <i>Options</i> &gt; <i>Language</i></li> </ul>	Menu
<p><b>Choose the tune</b></p> <ul style="list-style-type: none"> <li><i>Settings</i> &gt; <i>Phone</i> &gt; <i>Ringing</i></li> <li>Adjust the ring via the following menus: Melody, Silent, Beeps, Volume, etc.</li> </ul>	Menu
<p><b>Adjusting screen contrast</b></p> <ul style="list-style-type: none"> <li><i>Settings</i> &gt; <i>Phone</i> &gt; <i>Contrast</i></li> </ul>	Menu
<p><b>Modify the password for your phone set</b></p> <ul style="list-style-type: none"> <li><i>Settings</i> &gt; <i>Options</i> &gt; <i>Password</i></li> </ul>	Menu
<p><b>Homepage</b></p> <ul style="list-style-type: none"> <li><i>Settings</i> &gt; <i>Phone</i> &gt; <i>Homepage</i></li> <li>Select the default page.</li> </ul>	Menu